



## Response to Request for Information

Reference      FOI 002105  
Date            22 March 2018

### ***Bilston Road***

#### **Request:**

Request for information under the Freedom of Information Act 2000

I am writing to request information under the Freedom of Information Act relating to a road your authority is responsible for maintaining.

Specifically, my query relates to the B4484 Bilston Rd.

Please can you send me:

- 1) A copy of your current road maintenance policy relating to that road. Please send me the full policy, but this should include details of the intended frequency of road safety inspections, how these inspections should be conducted and the maximum time between identification of a defect and repairs being carried out. [The current highway safety inspection policy is appended as requested, the summary information requested in this question is as follows:](#)
  - [The minimum level of service for all highway sites is an annual walked inspection where it is safe for the inspectors to undertake them;](#)
  - [Additional inspections will be undertaken subject to available resources at a frequency based on the code of practice hierarchy classification, where this is identified by the carriageway classification driven inspections can be carried out;](#)
  - [Defects are categorised as either Category 1 or Category 2 refer to page 19 in the attached inspection policy.](#)
- 2) A copy of the road repair history for that road over the past year. Again, please send me the full road repair history, but this should include:
  - [dates of all safety inspections between 1st January 2018 and 22nd March 2018](#)  
[see attached report "Bilston Road Feature History List"](#)
  - [details of how safety inspections were undertaken \(walked or driven, speed of inspection vehicle etc\)](#)  
[Highway Safety Inspection 25/1/2018 – Driven](#)  
[Highway Safety Inspection 31/1/2018 – Walked](#)

Highway Safety Inspection 25/1/2018 – Driven

- details of all carriageway defects identified, with description, date and time see attached report “Bilston Road Feature History Report”
- details of how the authority handled these defects, what repairs were undertaken and the time between the identification of each defect and a repair being carried out.

The Job Status Log lists the status of each job raised as part of the inspection, Cat 1 defects will be dealt with within the planned response period. 3 No Cat 1 defects were identified as part of highway safety inspections during this period:

Defect Ref

660781 H:Carriageway Pothole – next day repair carried out on Job 338751 see Job Status Log;

660791 H:Public Utility Displaced (Footway) – Defect forwarded to relevant party for rectification as a Section 81 Notice – Defective Apparatus, NRSWA – on Job 338760 see Job Status Log;

660779 H:Traffic Signal Defect (Footway) – forwarded to UTC for further investigation.

We will try to deal with Cat 2 defects within the planned response period assigned to them subject to available resources. Please note we have just come through a very difficult period as a result of the extreme weather conditions some slippage will have occurred as maintenance teams have focussed on Cat 1 defects.

Inspection Type(s)						
H Highway Asset Capture						
H Highway Driven Safe Inspect						
H HIGHWAY FIND & FIX						
H Highway Safety Inspection						
H Monthly Safety Inspection						
H Six Monthly Safety Insp						
Site: BILSTON ROAD (44804560)			Area: The Lunt			
Asset No: 10,001.00		Asset Id - Location BILSTON ROAD - MOSELEY ROAD - RBT THE KEYWAY				
Feature Type: H:Highway Section			Contract Area: Highways			
Inspection	Date	Route	Type	Officer		
105078	07/03/2018	H Monthly Driven SE Route	H Highway Driven Safe Inspect	Linda Saxon		
102839	31/01/2018	H Bilston East	H Highway Safety Inspection	John Keates		
102503	25/01/2018	H Monthly Driven SE Route	H Highway Driven Safe Inspect	Linda Saxon		
Defect Details						
Defect	Description	Log Date	Location	Organise./Job	Priority	
663811		07/03/2018				
660805	BREAK UP AND TRIP BY REINSTATEMENT	31/01/2018	OS 44	388771	H:Cat 2 Med (90 Working Days)	
660796	KERB/KERB TRIP	31/01/2018	JCT OPP 47	388763	H:Cat 2 High (30 Working Days)	
660795		31/01/2018	JCT OPP 47	388762	H:Cat 2 Med (90 Working Days)	
660794	BITMAC LOW BY CTV BOX	31/01/2018	OS 70	388761	H:Cat 2 Low (180 Working Days)	
660791	BT BOX LOW/TRIP IN FOOTWAY	31/01/2018	OS BIG PAN /92	388760	H:Cat 1B (24 hour)	
660788	BITMAC BREAK UP AND TRIPS	31/01/2018	JCT MOSELEY ROAD/DARLASTON LANE	388757	H:Cat 2 Med (90 Working Days)	
660787	BITMAC TRIP BY KERB	31/01/2018	CENTRE RESERVATION OPP BIG PAN	388756	H:Cat 2 Low (180 Working Days)	
660786	TANGENT PATH BLOCK TRIPS	31/01/2018	JCT DARLASTON LANE	388755	H:Cat 2 Med (90 Working Days)	
660784	BITMAC BREAK UP	31/01/2018	20M FROM DARLASTON LANE	388753	H:Cat 2 High (30 Working Days)	
660781		31/01/2018	OS 61	388751	H:Cat 1B (24 hour)	
660780	BITMAC TRIPS	31/01/2018	OS 33 AROUND PDX	388750	H:Cat 2 High (30 Working Days)	
660779	PDX BOX COVER IN FOOTWAY DAMAGED WITH HOLE	31/01/2018	OS 33	388749	H:Cat 1B (24 hour)	
660236	Tarmac broken away	25/01/2018	By lights near big pan	388268	H:Cat 2 High (30 Working Days)	

Inspected: 01/01/2018 to 31/03/2018

Site: BILSTON ROAD (44804560)

Asset Number: 10001.00 to 10001.00

Report Type: Assessment

Site: BILSTON ROAD (44804560)

Area: The Lunt

Asset No: 10,001.00

Asset Id - Location: BILSTON ROAD - MOSELEY ROAD - RBT THE KEYWAY

Feature Type: H:Highway Section

Contract Area: Highways

Batch: 105078 - Inspection Batch

Route: H Monthly Driven SE Route

Officer: Linda Saxon

Date: 07/03/2018

Observation Type	Code	Grade	Score	Notes
H:Carriageway Network Survey	CNS	Aesthetically Impaired	2.0000	Structural in places
H:Footway Network Survey	FNS	Aesthetically Impaired	2.0000	

Defect No.	Description	Log Date	Location	Type	Organisation	Status
663811		07/03/2018		NONE		Unactioned

Batch: 102839 - Inspection Batch

Route: H Bilston East

Officer: John Keates

Date: 31/01/2018

Observation Type	Code	Grade	Score	Notes
H:Carriageway Network Survey	CNS	Aesthetically Impaired	2.0000	Structural in places
H:Footway Network Survey	FNS	Aesthetically Impaired	2.0000	

Defect No.	Description	Log Date	Location	Type	Organisation	Status
660805	BREAK UP AND TRIP BY REINSTATEMENT	31/01/2018	OS 44	CWDA		Uncommitted
660796	KERB/KERB TRIP	31/01/2018	JCT OPP 47	KBDI		Uncommitted
660795		31/01/2018	JCT OPP 47	GYBL		Uncommitted
660794	BITMAC LOW BY CTV BOX	31/01/2018	OS 70	FWDE		Uncommitted
660791	BT BOX LOW/TRIP IN FOOTWAY	31/01/2018	OS BIG PAN /92	PUDI		Uncommitted
660788	BITMAC BREAK UP AND TRIPS	31/01/2018	JCT MOSELEY ROAD/DARLASTON LANE	CWDA		Uncommitted
660787	BITMAC TRIP BY KERB	31/01/2018	CENTRE RESERVATION OPP BIG PAN	FWUN		Uncommitted
660786	TANGENT PATH BLOCK TRIPS	31/01/2018	JCT DARLASTON LANE	FWUN		Uncommitted
660784	BITMAC BREAK UP	31/01/2018	20M FROM DARLASTON LANE	CWDA		Uncommitted
660781		31/01/2018	OS 61	CWPH		Uncommitted
660780	BITMAC TRIPS	31/01/2018	OS 33 AROUND PDX	CWDA		Uncommitted
660779	PDX BOX COVER IN FOOTWAY DAMAGED WITH HOLE	31/01/2018	OS 33	TSDA		Uncommitted

Batch: 102503 - Inspection Batch

Route: H Monthly Driven SE Route

Officer: Linda Saxon

Date: 25/01/2018

Observation Type	Code	Grade	Score	Notes
H:Carriageway Network Survey	CNS	Functionally Impaired	3.0000	Structural in places
H:Footway Network Survey	FNS	Aesthetically Impaired	2.0000	

Defect No.	Description	Log Date	Location	Type	Organisation	Status
660236	Tarmac broken away	25/01/2018	By lights near big pan	CWPH		Uncommitted

Site: BILSTON ROAD (44804560)

Jobs with: All

Noticing: All

Notice Status: All

Job Log No.	Date/Time	Effective Date/Time	Allocated To	Status
Site: BILSTON ROAD (44804560)		Area: The Lunt		
Asset No:	10,001.00	Asset:	Location: BILSTON ROAD - MOSELEY ROAD - RBT THE	
Job: 388268	Tarmac broken away (H:Carriageway Pothole)		Work Locn: By lights near big pan	
1 25/01/2018 13:22:26	25/01/2018 13:20:53	Responsive Maintenance Defects	Job Raised	
Job: 388749	PDX BOX COVER IN FOOTWAY DAMAGED WITH HC		Work Locn: OS 33	
1 31/01/2018 10:14:29	31/01/2018 10:12:44	Urban Traffic Control	Job Raised	
Job: 388750	BITMAC TRIPS (H:Carriageway Damaged)		Work Locn: OS 33 AROUND PDX	
1 31/01/2018 10:16:43	31/01/2018 10:15:09	Responsive Maintenance Defects	Job Raised	
Job: 388751	H:Carriageway Pothole		Work Locn: OS 61	
3 01/02/2018 13:42:14	01/02/2018 13:42:14	Responsive Maintenance Team 3	Job Closed	
2 01/02/2018 11:52:33	01/02/2018 11:52:33	Responsive Maintenance Team 3	Arrived at Site	
1 31/01/2018 10:22:55	31/01/2018 10:21:13	Responsive Maintenance Team 3	Job Raised	
Job: 388753	BITMAC BREAK UP (H:Carriageway Damaged)		Work Locn: 20M FROM DARLASTON LANE	
1 31/01/2018 10:26:30	31/01/2018 10:24:33	Responsive Maintenance Defects	Job Raised	
Job: 388755	TANGENT PATH BLOCK TRIPS (H:Footway Uneven)		Work Locn: JCT DARLASTON LANE	
1 31/01/2018 10:29:26	31/01/2018 10:27:17	Responsive Maintenance Defects	Job Raised	
Job: 388756	BITMAC TRIP BY KERB (H:Footway Uneven)		Work Locn: CENTRE RESERVATION OPP BIG PAN	
1 31/01/2018 10:31:46	31/01/2018 10:30:28	Responsive Maintenance Defects	Job Raised	
Job: 388757	BITMAC BREAK UP AND TRIPS (H:Carriageway Dama		Work Locn: JCT MOSELEY ROAD/DARLASTON LANE	
1 31/01/2018 10:34:18	31/01/2018 10:32:11	Responsive Maintenance Defects	Job Raised	
Job: 388760	BT BOX LOW/TRIP IN FOOTWAY (H:Public Utility Disp		Work Locn: OS BIG PAN /92	
2 01/02/2018 15:39:59	01/02/2018 15:39:55	Rob Edwards	Job Closed - S81 Issued	
1 31/01/2018 10:38:16	31/01/2018 10:35:58	Rob Edwards	Job Raised	
Job: 388761	BITMAC LOW BY CTV BOX (H:Footway Depression)		Work Locn: OS 70	
1 31/01/2018 10:44:25	31/01/2018 10:42:28	Responsive Maintenance Defects	Job Raised	
Job: 388762	H:Gully Blockage		Work Locn: JCT OPP 47	
1 31/01/2018 10:46:06	31/01/2018 10:45:07	Responsive Maintenance Defects	Job Raised	
Job: 388763	KERB/KERB TRIP (H:Kerb Displaced)		Work Locn: JCT OPP 47	
1 31/01/2018 10:47:37	31/01/2018 10:46:11	Responsive Maintenance Defects	Job Raised	
Job: 388771	BREAK UP AND TRIP BY REINSTATEMENT (H:Carria		Work Locn: OS 44	
1 31/01/2018 10:53:41	31/01/2018 10:51:34	Responsive Maintenance Defects	Job Raised	

**WOLVERHAMPTON CITY COUNCIL**  
**Highway Safety Inspection Policy**  
**April 2015**

## Contents

### Executive Summary

- 1.0 Introduction
- 1.1 Control of Document
- 1.2 Introduction to Policy
- 1.3 Highway Safety Inspection Policy
  
- 2.0 The Purpose of Highway Safety Inspections
  
- 3.0 Wolverhampton's Highway Network
  - 3.1 Network Hierarchy
  - 3.2 Carriageway Hierarchy
  - 3.3 Footway Hierarchy
  - 3.4 Cycleway/track Hierarchy
  
- 4.0 Inspection Frequencies
  - 4.1 National Code of Practice and Highway Safety Inspections
  - 4.2 Minimum Level of Service
  - 4.3 Planned Level of Service
  - 4.4 Adverse/Extreme Weather Conditions
  - 4.5
  
- 5.0 Defect Categorisation
  - 5.1 Inspection Types
  - 5.2 Highway Safety Inspection Defect Categories
  - 5.3 Highway Service Inspection Defect Categories
  - 5.4 Defect Risk Assessment – degree of deficiency and nature of response
  - 5.5 Defect Intervention Criteria
  
- 6.0 Methodology of Safety Inspections
  - 6.1 Walked Inspections
  - 6.2 Driven Inspections
  - 6.3 Training and Competencies
  - 6.4 Health and Safety
  - 6.5 Responsibilities for Persons Undertaking Inspections
  
- 7.0 Information Recorded on Inspection
  - 7.1 Recording of Defect
  - 7.2 The Position of the Defect
  - 7.3 Describing Defects
  - 7.4 Sizing of Defects
  - 7.5 Taking Photos of Defects

Appendix A	Defect Risk Assessment
Appendix B	Intervention Levels
Appendix C	Inspection Process
Appendix D	Health & Safety: Risk Assessment
Appendix E	Inspection Routes & Schedule of Driven Sites
Appendix F	Network Categorisation Record
Appendix G	Highway Defect Codes



## Highway Safety Inspection Policy: Executive Summary

Wolverhampton City Council, as the local highway authority, is responsible for a network of public highway with a road length of over 735 km it also has a statutory duty under Section 41(1) of the Highways Act 1980 to maintain “a highway maintainable at the public expense.” Failure in this duty can lead to claims for compensation.

The responsibility to maintain the highway is an open ended task. To assist highway authorities in meeting this duty Section 58 of the Highways Act 1980, allows the use of a “Special Defence” in respect of action against it for damages for non-repair of the highway. The Council must prove that it has taken such care as was reasonable, part of the defence rests upon: “Whether the highway authority knew, or could reasonably have been expected to know, that the condition of the part of the highway to which the action relates was likely to cause danger to users of the highway”.

By virtue of Section 58 of the Highways Act 1980 the Council are able to repudiate a claim relating to alleged injury, loss or damage if it can prove that:

- It had in place adequate policies and procedures to maintain the highway.
- The policies and procedures were being implemented effectively.

The Highway Safety Inspection Policy details how the Council will provide a programme of inspections to identify, record, report and subsequently repair those defects on the publically maintainable highway that may present a hazard to road users or a risk of rapid deterioration in the fabric of the highway. The inspection frequency reflects the guidance contained in the national code of practice:-

Feature	Ref	Category	Inspection Frequency
Carriageways	2	Strategic Routes	1 month
	3(a)	Main Distributors	1 month
	3(b)	Secondary Distributors	1 month
	4(a)	Link Access	3 Months
	4(b)	Local Access	1 Year
Footways	1(a)	Prestige Area	1 Month
	1	Primary Walking Route	1 Month
	2	Secondary Walking Route	3 Months
	3	Link Footway	6 Months
	4	Local Access Footway	1 Year

Walked inspections will be undertaken on all roads in the City on at least an annual basis except where it is unsafe to do so, driven surveys will take place on these routes which includes the Black Country Route and sections of the Ring Road.

Defects will be categorised based on the risk they present to highway users and the potential for further deterioration.

Category 1 defects will be repaired or made safe within 2 hours when they are assessed as presenting a serious risk to safety, for example exposed electrical wiring, or are dealt with as a matter of priority within 24 hours or next working day when the defect represent an immediate or imminent hazard.

It is intended that Category 2 defects will be repaired as part of a programme of planned works, the repair should be programmed for completion before the next inspection is due.

This document is intended as a procedural guide for all employees or contractors involved in the inspection and repair of defects on Wolverhampton's highway network. Initially it is expected to cover defects identified through the regular programme of highway safety inspections and service inspections.

The Policy has been produced in accordance with the guidance and recommendations made in the UK Roads Liaison Group's *"Well Maintained Highways - Code of Practice for Highway Maintenance Management"* (CoP), local guidance notes and other relevant documents. It will be subject to a regular review to take account of changing circumstances, our experience, case law and as national guidance is amended or updated.

# 1. Introduction

## 1.1 Control of Document

The Risk Team Leader and Service Lead, Highway Assets will hold a signed original copy of each revision of the Wolverhampton City Councils (the Council) highways safety inspection policy document.

## 1.2 Introduction to Policy

The establishment of an effective regime of inspection, assessment and recording is the most critical element of highway management and maintenance. The safety inspection regime provides the basic information for addressing the first core objective of highway maintenance and network safety.

The purpose of this document is to identify the policy and provide the guidance to support its delivery with a consistent approach to the identification, categorisation and repair of highway defects, providing whenever possible or practicable a first time permanent repair solution to maintain and improve Wolverhampton's highway network.

It is intended as a procedural guide for all employees or contractors involved in the inspection and repair of defects on Wolverhampton's highway network. Initially it is expected to cover defects identified through the regular programme of highway safety inspections it will also serve to support the identification of defects as part of a service inspection. The categorisation and repair of these defects does not attempt to address more detailed inspections, condition surveys or inspections of Public Rights of Ways (PROW), street lighting and detailed tree inspections.

This policy document is based on the principles contained in the "*Well Maintained Highways - Code of Practice for Highway Maintenance Management*" (CoP), local guidance notes and other relevant documents. It will be reviewed at regular intervals and as the current guidance is updated.

### **1.3 Highway Safety Inspection Policy**

The Council commits to undertake regular inspections of the highway network to identify record and prioritise for repair those defects that may present an immediate hazard to road users. Other defects may also be recorded for inclusion in a programme of planned works or where the asset is not in Council ownership for referral to a third party.

The policy will ensure that all highway sites are subject as a minimum to an annual walked inspection where they can be carried out without risk to the inspector or the public. Where a site cannot safely be inspected on foot a driven inspection will be undertaken.

Additional inspections can be carried out, subject to the availability of resources these may be walked or driven as determined by the sites hierarchy categorisation, at frequencies in accordance with the recommendations made in the Well Maintained Highways Code of Practice with local amendments as detailed in this document to take account of local requirements.

## 2.0 The Purpose of Highway Safety Inspections

Under Section 41 of the Highways Act 1980 Wolverhampton City Council has a statutory duty “to maintain a highway maintainable at public expense” in a safe and serviceable manner for all road users. Failure in this duty can lead to claims against the Council for compensation resulting from a failure to maintain the highway.

There is no definition in the act as to the level of maintenance required although national codes have been produced to offer some guidance. "Well Maintained Highways - A Code of Practice for Maintenance Management" (CoP) produced by the UK Roads Liaison Group, provides comprehensive guidance to assist local authorities. The CoP makes recommendations for surveys and inspections of the adopted highway network, except where local constraints or demands have required local solutions.

Under Section 58 of the Highways Act 1980, the highway authority can use a “Special Defence” in respect of action against it for damages for non-repair of the highway if it can prove that it has taken such care as was reasonable. Part of the defence rests upon:

*“Whether the highway authority knew, or could reasonably have been expected to know, that the condition of the part of the highway to which the action relates was likely to cause danger to users of the highway”.*

This is where the Council has to show that it carries out highway safety inspections in accordance with its policies and national guidance. By virtue of Section 58 of the Highways Act 1980 the Council are able to repudiate a claim relating to alleged injury, loss or damage if it can prove that:

- It had in place adequate policies and procedures to maintain the highway.
- The policies and procedures were being implemented effectively.

### 2.1 Highway Safety Inspections

Safety Inspections are designed to identify all defects likely to cause danger or serious inconvenience to users of the network or the wider community. Such defects include those that require urgent attention as well as those where the locations and

sizes are such that longer periods of response are appropriate. The Safety Inspection regime forms a key aspect of the Councils strategy for managing liability and risk.

The following is a list of items that are expected to be included within safety inspection:-

<b>Item</b>	<b>Defect</b>
Carriageway and Cycleway	pot hole/spalling, ridge, hump, depression/sunken cover or gap/crack
Footway	trip/pot hole/sunken cover, rocking slab/block or open joint
Kerb	misaligned, loose / rocking or missing
Verge	sunken area adjacent to and running parallel with the carriageway / footway edge or obstruction
Iron Work	Gaps within framework, level differences within framework, rocking / cracked / broken / worn / polished or missing covers
Flooding – where conditions allow	standing water, water discharging onto or flowing across the running surface, significant flooding of property
Drainage	substantial standing water adjacent to edge of c/way, blocked gully/kerb outlet or collapsed/ blocked/settled items or systems
Road Markings	Faded or worn markings
Road Studs / Eyes	Missing, void left in c'way, displaced items on c'way or defective studs / eyes.
Signs / Bollards / Lights / Traffic signals	damaged/misaligned items causing a hazard, missing items causing a hazard, lights/signals not operating correctly/malfunctioning, signals pointing the wrong way, signal lamp failure, exposed wiring, missing doors to lamp columns and electrical enclosures, items missing or items obscured/dirty/faded
Safety Fencing / Barriers	damaged/misaligned items projecting into c/way or f/way or structurally unstable items likely to cause danger
Hedges and trees	overhanging trees and vegetation or unstable trees and branches. Damage associated to tree roots.
Highway General	oil/debris/mud/stones/gravel likely to cause a hazard, illegal signs, obstructions on the highway, obstructed sight lines, ramps in c/way to aid vehicular movement, f/way damage caused by vehicular access where no vehicle crossing, scaffolding or skips likely to cause a hazard, unprotected building materials on the

	highway or abandoned vehicles likely to cause a hazard
Anything Dangerous	anything considered dangerous on the highway which could affect either highway users or the general public

## 2.2 Service Inspections

These mainly comprise more detailed inspections tailored to the requirements of particular highway elements to ensure that they meet requirements serviceability. The scale and scope of these inspections is optional, they are normally undertaken in response to an enquiry or complaint received from the public or others regarding the highway.

A third party claim will generate a discrete Service Inspection as part of the claim investigation process which will seek to identify and document the cause of the alleged incident. The Council as part of its normal practice will undertake repairs, if any are deemed necessary, to defects identified as part of such an inspection, in order to reduce the risk that further incidents are caused by the alleged defect. Any repairs from such an inspection should be undertaken as part of the planned works programme unless the defect presents as either a Cat 1a or Cat 1b in which case those timescales for repair will be implemented.

Service inspections also includes those required for regulatory purposes, including the New Roads and Street Works Act 1991 (NRSWA) inspections, intended to maintain network availability and reliability. It also includes less frequent inspections for network integrity.

## 2.3 Highway Condition Surveys

These surveys are intended to identify deficiencies in the highway fabric which, if untreated, are likely to adversely affect its long term performance and serviceability. These surveys are used to assist with the identification of future works programme and to satisfy the requirements of statutory performance indicators.

## 2.4 Resources

In delivering its 'duty of care' to users of the highway, the Council provides financial and operational resources. This allows operations to be carried out in both a planned and reactive manner in maintaining the highway in a safe condition.

#### **2.4.1 Budgets**

Each year the Council determines the allocation of its financial resources with due consideration of its strategic aims and priorities. The Highway Maintenance Budget is one area of allocation which is split into a number of service delivery areas, each with dedicated budgets. A high regard to the safety of the users of the highway means that the Council sets aside an allocation specifically for undertaking repairs identified during safety and service inspections.

#### **2.4.2 Safety Inspectors**

To undertake its cyclic safety inspections the Council has engaged a team of officers specifically trained in this activity. The inspectors are supported by other members of the Highway Assets Section and by the Responsive Highway Maintenance Streetscene Services Highway Technicians, who monitor progress, provide advice and supervision. Complaints are dealt with by the Highway Technicians as part of a Service Inspection.

#### **2.4.3 Emergency repairs**

The Safety Inspectors and Area Technicians are supported operationally by supervisory staff who arrange for the works identified during the inspection to be undertaken to strict deadlines. Performance is closely monitored and the monitoring forms one of the service's local performance indicators. Emergency repairs are undertaken by readily available teams, two maintenance teams are routinely engaged in undertaking defect repairs arising from safety Inspections, other teams can be called in to provide support as and when required. The additional resource would be provided either through scheduling or breaking off from their normal highway maintenance activities.



## 3.0 Wolverhampton’s Highway Network

The Council is responsible, as the local highway authority, for all of the adopted public highways, rights of way and cycle tracks in the City, a network of over 735km.

### 3.1 Network Hierarchy

The highway network has been assigned a hierarchy which relates to its importance to transportation and level of usage. This hierarchy is recorded in the Highway Asset Management System. Footway hierarchies are different to carriageway hierarchies and therefore most roads have different hierarchy classification and potentially a different inspection frequency for carriageway and footway. The following tables are extracted from the current version of Well Maintained Highways with route lengths for each category of road. These tables are intended to be used as a reference point from which to develop local hierarchies.

### 3.2 Carriageway Hierarchy

The carriageway hierarchy defined in the Code of Practice is interpreted in Wolverhampton as below to define a local road network, it remains consistent with the theme of the national CoP, the local network is predominantly urban, with a network of bus routes that are likely to use sites in all 5 hierarchy categories.

Category	Name	Types of Road and General Description Local Description/ Categorisation	Routes Length (KM)
2	Strategic route	Principal 'A' Roads	84
3a	Main distributor	Classified Non-Principal B Roads	15
3b	Secondary distributor	Classified Non-Principal C Roads and other locally significant routes	57
4a	Link road	Roads linking between the Main and Secondary Distributor Network with frontage access and frequent junctions.	60
4b	Local access road	Roads serving limited numbers of properties carrying only access traffic.	519
Total Network Length km			735

Table 1 – Carriageway Hierarchy

### 3.3 Footway Hierarchy

The footway hierarchy defined in the Code of Practice is interpreted in Wolverhampton as follows:

Category	Name	Brief Description	Routes Length (KM)
1a	Prestige walking routes	Very busy areas of towns and cities with high public space and street scene contribution.	2.4
1	Primary walking routes	Busy urban shopping and business areas and main pedestrian routes.	100.0
2	Secondary walking routes	Medium usage routes through local areas feeding into primary routes, local shopping centres, etc.	120.6
3	Link footways	Other footways alongside roads with carriageway categories 2, 3a, 3b and 4a	18.0
4	Local access footways	Footways alongside local access roads (carriageway category 4b) and footpaths within estates.	602.1
		Total Network Length	843.1

Table 2 – Footway Hierarchy – note the route length given is based on current information

The footway hierarchy provides a consistent and clear approach towards the undertaking of routine inspections which is in line with the overall approach set out in the national Code of Practice. However further consideration of its adequacy is needed in the light of statements in the Code of Practice to the effect that:

- Footway hierarchy should not necessarily be determined by road classification, but also by the functionality of the footway and scale of use.
- Particular local circumstances, such as proximity to school, hospitals, medical centres should be taken into account in determining inspection frequency.

### 3.4 Cycle Route Hierarchy

A separate network has not currently been defined for maintenance purposes, where the route forms part of the adopted highway it will be included in the existing inspection associated with that site.

The CoP has provided the following guidance to assist with the definition of a cycle route network, it makes the following statement:

*They are categorised not by use or functionality but by location, as the level of use is generally low and not related to maintenance need. This approach also reflects the differing risks associated with shared, partially segregated and fully segregated cycle routes. Where the level of use on particular cycle routes is significant and relevant to maintenance need, for example on commuter cycle routes, authorities may establish categories based on use.*

<b>CoP: Cycle Route Hierarchy</b>	
<b>Category</b>	<b>Description</b>
A	<i>Cycle lane forming part of the carriageway, commonly 1.5 metre strip adjacent to the nearside kerb. Cycle gaps at road closure point (no entries allowing cycle access).</i>
B	<i>Cycle track, a highway route for cyclists not contiguous with the public footway or carriageway. Shared cycle/pedestrian paths, either segregated by a white line or other physical segregation, or un-segregated.</i>
C	<i>Cycle trails, leisure routes through open spaces. These are not necessarily the responsibility of the highway authority, but may be maintained by an authority under other powers or duties.</i>

## 4.0 Inspection Frequencies

### 4.1 National Code of Practice and Highway Safety Inspections

The number of planned inspections the Council carries out per year relates to the road location and classification which meets the suggested frequency outlined in the Code of Practice for Maintenance Management - Well Maintained Highways (CoP), which can either be walked or driven.

The Council has set its own standards for the frequency of its highway safety inspections. These take into account national guidelines for the definition highway type, hierarchy as detailed in Section 3 and inspection frequencies, issued in the CoP. The frequencies are recommendations; they are provided for guidance and are not mandatory standards, they assist us in the establishment of our standard and associated level of service.

Feature	Ref	Category	Inspection Frequency
Carriageways	2	Strategic Routes	1 month
	3(a)	Main Distributors	1 month
	3(b)	Secondary Distributors	1 month
	4(a)	Link Access	3 Months
	4(b)	Local Access	1 Year
Footways	1(a)	Prestige Area	1 Month
	1	Primary Walking Route	1 Month
	2	Secondary Walking Route	3 Month
	3	Link Footway	6 Months
	4	Local Access Footway	1 Year

Table 4 – Frequency of Highway Safety Inspections- Well Maintained Highways Code of Practice

## 4.2 Minimum Level of Service

The Highway Safety Inspection Policy has identified a minimum level of service that must be provided for all recorded highway sites, an annual inspection, this shall be undertaken on foot unless the nature of the site presents a hazard to the inspector, in such circumstances a driven inspection is acceptable.

A schedule of sites will be maintained identifying those sites that are not suitable for walked inspections.

## 4.3 Planned Level of Service

The table below illustrates Wolverhampton's network hierarchy in kilometres with both the carriageway and footway hierarchy. The Council has adopted the view that the highway safety inspection frequency should be based on the footway classification.

A walked inspection will include all elements of the highway by their nature they afford inspectors a broader view of the highway and its component parts.

Therefore should the footway hierarchy require a monthly inspection and the carriageway an annual inspection, this route would be subject to twelve detailed walked inspections and one annual driven inspection.

Carriageway Hierarchy		2	3a	3b	4a	4b
Footway Hierarchy	1a	0	0	0	0	0
	1	91.5 km	0.2 km	0.3 km	0.7 km	9.8 km
	2	35.1 km	5.6km	0.3 km	0.4 km	64.3 km
	3	1.7 km	1.2 km	5.0 km	0.2 km	9.9 km
	4	52.2 km	9.5 km	14.5 km	2.9 km	523 km

Table 5 – The Council's Network Hierarchy

Table 6 below illustrates a mixed inspection profile, utilising both walked and driven inspections, which would meet the recommendations regarding frequency of inspection based on both a sites footway and carriageway hierarchy categorisation. The profile assumes that a footway will always need a walked inspection and that a driven inspection can be utilised for those occasions where the carriageway hierarchy promotes a higher frequency of than that needed for the footway.

	Carriageway Hierarchy									
	2		3a		3b		4a		4b	
	(Monthly)		(Monthly)		(Quarterly)		(Annual)		(Annual)	
Footway Hierarchy	walked	Driven	walked	Driven	walked	Driven	walked	Driven	walked	Driven
1a (Monthly)	12	0	12	0	12	0	12	0	12	0
	12		12		12		12		12	
1 (Monthly)	12	0	12	0	12	0	12	0	12	0
	12		12		12		12		12	
2 (Quarterly)	4	8	4	8	4	0	4	0	4	0
	12		12		4		4		4	
3 (6 Monthly)	2	10	2	10	2	2	2	0	2	0
	12		12		4		2		2	
4 (Annual)	1	11	1	11	1	3	1	0	1	0
	12		12		4		1		1	

Table 6 – Table Illustrating Highway Safety Inspection Profile – Walked and Driven Inspections

#### 4.4 Exceptional Circumstances

The planned programme of inspections may need to be adjusted to take account of exceptional circumstance that may either prevent or delay the planned routine inspection from being carried out. Typically these delays are likely to be as a result of adverse weather conditions; reduced access to the road space as a result of utility or other works; lack of inspection resources due to illness/injury or other absence.

**4.4.1 Adverse Weather Conditions** – This would relate to periods when weather conditions prevent routine inspections from being carried out this would include heavy rain resulting in standing water on the surface, snow or ice all of which hinder

an effective inspection. In such circumstances safety inspections may need to be suspended, a defect record will be entered into the inspection system noting that no inspection was possible with a short note explaining why it has not been possible to undertake the inspection. During periods of prolonged cold weather with snow on the ground a reduced inspection may be undertaken on a limited basis to inspecting the Strategic Routes, Main and Secondary Distributor Network. The focus of these inspections would be to identify carriageway damage that is likely to result from these weather conditions such as potholes.

**4.4.2 Restricted Access to Site** – In exceptional circumstances, it may not be possible to carry out inspections due to other works occupying the highway, for example a statutory undertaker is renewing their mains services under a road closure. In these circumstances, the Safety Inspection will note that access to the site in part or whole was prevented and a no inspection record created as per 4.4.1.

## **5.0 Defect Categorisation**

### **5.1 Inspection Types**

The guidance in this policy relates to Highway Safety Inspections and Service Inspections, the defects that are assessed will use the same defect description and categorisation scheme. This will still allow defects identified by Highway Safety Inspection to be clearly differentiated from those recorded as part of a Service Inspection. The response times associated with the categories will be the same as will the risk assessment framework that will be available to support the decision making process.

Note, at all times the final decision as to the allocation of the defect category will be with the inspector undertaking the task.

### **5.2 Highway Safety Inspection Defect Categories**

The CoP defines defects in two categories:-

- Category 1 - those that require prompt attention because they represent an immediate or imminent hazard or because there is a risk of short-term structural deterioration.
- Category 2 - all other defects which, following a risk assessment, are deemed not to represent an immediate or imminent hazard or risk of short term structural deterioration. Such defects may have safety implications, although of a far lower significance than Category 1 defects, but are more likely to have serviceability or sustainability implications. These defects are not required to be urgently rectified, and those for which repairs are required shall be undertaken within a planned programme of works, with the priority as determined by risk assessment. These priorities together with access requirements, other works on the road network, traffic levels, and the need to minimise traffic management, should be considered as part of the overall asset management strategy. The programmes of work for their rectification should be part of the Highway Asset Management Plan ( HAMP).



For the purposes of our inspections these defect categories have been refined further with the following response times:

### **5.3 Category 1A defects (repair or make safe within 2 hours)**

Category 1A defects have a local target response time of 2 hours and should be reported to the reactive maintenance team immediately at the time of inspection using the mobile phone carried by the surveyor.

Examples of Category 1A defects include:

- Missing covers to large chambers, manholes, gully gratings, etc.
- Substantial debris or obstruction of carriageway (e.g. brick, large piece of metal, fallen tree branch)
- Exposed electrical wiring
- Any significant highway structure in imminent danger of collapse including, for example, street lighting columns, traffic signs, traffic signal poles, retaining walls or large chamber/ manhole covers

### **5.4 Category 1B defects (repair or make safe within 24 hours/next working day)**

These defects represent an 'immediate or imminent hazard'. A list will be printed out at the end of the day's inspection and faxed to the highways term contractor for action to be taken the following day. Examples of Category 1B defects include:

- Trips greater than 25mm in busy footways and pedestrian areas (e.g. city centre, on the carriageway at controlled pedestrian crossings);
- In carriageways any pothole greater than 50mm deep, or any other defect causing a trip/ sharp difference in levels greater than 50mm;
- Any other defect that, in the surveyor's view, requires urgent attention because it represents an immediate or imminent hazard to highway users.

## 5.5 Category 2 Defects

Category 2, are those defects that do not represent an imminent or immediate hazard, but where a repair is required, can be undertaken within a planned programme of work. To assist with the development of this programme Category 2 defects will be categorised according to priority as, high, medium or low.

Each priority would have target response time that considers the nature of the defect, its location on the network, its associated risk probability and likely impact. This should take into account the likelihood of further deterioration before the next scheduled inspection.

5.5.1 Cat 2A High Priority - Category 2 (30 Day Repair) defects are those that WILL, in the opinion of the inspector, become Cat 1 within 3 months if not attended to.

5.5.2 Cat 2B Medium Priority - Category 2 (90 Day Repair) defects are those that are LIKELY to become Cat 1 in 3-12 months' time. We will monitor our performance of rectifying these defects within 90 working days depending upon the available budget.

5.5.3 Cat 2C Low Priority - Category 2 (180 Day Repair) defects are those that are LIKELY to become Cat 1 in 3-12 months' time. We will monitor our performance of rectifying these defects within 180 working days depending upon the available budget.

<b>Defect category</b>	<b>Description</b>	<b>Target Response within</b>
Cat 1A	Dangerous Defects	2 Hours
Cat 1B	Defects represent an 'immediate or imminent hazard'	24 Hours/next working day
Cat 2A	Category 2 (30 Day Repair) defects are those that WILL become Cat 1 within 3 months if	30 days

	not attended to. Any Service Inspection undertaken as part of a third party claim investigation should also use this categorisation for any defect identified as the cause of an incident unless the defect presents as a Cat 1 or it is not deemed necessary to repair.	
Cat 2B	Category 2 (90 Day Repair) defects are those that are LIKELY to become Cat 1 in 3-12 months' time. We will monitor our performance of rectifying these defects within 90 working days depending upon the available budget.	90 days
Cat 2C	Category 2 (180 Day Repair) defects are those that are LIKELY to become Cat 1 in 3-12 months' time. We will monitor our performance of rectifying these defects within 180 working days depending upon the available budget.	180 days

Table 7: Defect Categories and Response Times

Types of defects that may be recorded include:

- In footways and pedestrian areas (including controlled pedestrian crossings) any hole, gap or missing/loose/broken unit leading to a trip hazard greater than 20mm
- In carriageways any pothole greater than 25mm deep, or any other defect causing a trip/ sharp difference in levels greater than 25mm
- Missing covers to small chambers (stop tap covers or similar)
- Broken/missing Give Way or Stop signs
- Damaged guard rails
- Any other defect that, in the surveyor's view, whilst not presenting an immediate hazard needs regular monitoring

## 5.6 Highway Service Inspection Defect Categories

The defect categorisations and response times will also be used to support the highway service inspections these will be recorded as Ad-Hoc defects to allow them to be clearly differentiated from Safety Inspections. The Service Inspection undertaken as part of a third party claim investigation should use the Cat 2A categorisation for any defect identified as the cause of an incident, unless the defect presents as a Cat 1 or it is not deemed necessary to repair..

### **5.7 Risk Assessment - Degree Of Deficiency And Nature Of Response**

The defect category selection will depend on the inspector's assessment at the point of inspection which should be based on and take account of the following factors:

- Overall probability and impact of damage or accident occurrence;
- Hierarchy and frequency of inspection from Table 4;
- The depth, surface area – scale and extent of defect;
- Location of defect relative to other highway features such as junctions, bends, pedestrian crossings:
- Location of the defect and its potential impact on road users;
- Whether the defect is in a main shopping area or other busy location.
- Position in relation to likely route of pedestrians, e.g. whether in middle or at back edge of footway.
- Usage of adjacent buildings such as old people's homes, sheltered accommodation, etc.
- The likelihood of further rapid deterioration and the requirement for permanent or temporary repair

5.7.1 It is important to recognise that these are guidelines only, not a precise specification. Surveyors will exercise their judgement and discretion in deciding whether to record an individual defect, and in which category to place it.

5.7.2 This policy has been developed around our existing practices, the intention will be to adopt the approach to the assessment of risk detailed in the CoP, see

Appendix A, this will be used as the starting point for the development of a local standard.

## 5.8 Defect Intervention Criteria

To assist inspectors the following schedule summarises the current defect intervention criteria/thresholds:

Road type	Defect description	Category 1	Category 2
<b>Footways</b>	Hole, gap, missing/ loose/ broken unit leading to trip	>25mm	>20mm
<b>Footways – busy &amp; pedestrian areas (including controlled pedestrian crossings)</b>	Trips	>25mm	
<b>Carriageways</b>	Pothole	>50mm	>25mm
<b>Carriageways</b>	other defect( trip / sharp difference in levels)	>50mm	>25mm
<b>Footways/ Carriageways</b>	Any other defect identified by the surveyor likely to be hazardous	✓	
<b>Footways/ Carriageways</b>	Any other defect identified by the surveyor not immediately hazardous needing regular inspection		✓

Table 8: Defect intervention level

## **6.0 Methodology of Inspections**

The number of programmed inspections the Council carries out per year relates to the road location and classification meeting the suggested frequency outlined in the CoP, which can either be walked or driven.

In general highway safety inspections are carried out from a slow moving vehicle or on foot. Surveys will be undertaken in terms of the feature being inspected. Where the objective of the inspection is footways, the inspection will be walked; where carriageways are being inspected this survey would be driven. General control measures are stated below but should not be considered exhaustive.

### **6.1 Driven Inspections**

Driven safety inspections must always be undertaken by two people in a suitable vehicle travelling at a speed that will enable adequate recording of defects – (guidance speed is 20mph). The method is that one person will be driving and the other inspecting. The driver must not be actively involved in identifying and recording defects, but will concentrate on ensuring the vehicle is driven safely.

- The vehicle being used must be equipped with the appropriate beacons and reflective signing, and the equipment used where appropriate. High visibility personal protective equipment and clothing must be worn at all times.
- Should the vehicle need to stop, the vehicle shall be parked in safe position and the roof mounted beacons must be switched on.
- Other motorists must not be forced across any continuous white centre lining. If this cannot be achieved, advanced temporary traffic signing must be installed.
- Planned highway safety inspections shall not be carried out under conditions of poor visibility or extreme weather conditions e.g. snow, ice, fog or heavy rain. When possible inspections shall be carried out during off peak hours 09:30 to 15:30 hrs when pedestrian and vehicle movements are low.

## **6.2 Walked Inspections**

- Appropriate high visibility personal protective equipment and appropriate safety clothing must be worn at all times.
- Lone working procedures must be followed.
- Inspections should be conducted from the footway or verges where possible.
- Planned highway safety inspections should not be carried out under conditions of poor visibility or extreme weather conditions e.g. snow, Ice, fog or heavy rain.

## **6.3 Training and Competences**

Appropriate training will be provided to personnel responsible for managing and carrying out highway inspections. New inspectors will be provided with in-house training and will in due course complete the appropriate training.

## **6.4 Health and Safety**

All inspections should be carried out in a safe manner so as not to endanger themselves, colleagues or members of the public in accordance with the risk assessment identified for highway safety inspections. See Appendix D for the risk assessment for highway safety inspections.

## **6.5 Responsibilities for Persons Undertaking Inspections**

The highway safety inspector undertaking the inspection is responsible for the accuracy of the inspection they undertake and the information recorded. Where claims are made against the authority, there may be instances where the inspector may be called into court to substantiate their inspection records. In addition to this the highway safety inspector may also be required to provide information relating to third party claims received and provide statements towards the defence of claims when requested by the Council.



## **7.0 Information Recorded on Inspections**

Each inspection undertaken should be recorded against the relevant highway section in Councils asset management system. The information recorded during the inspection may be used to undertake works to defects requiring a response as well as identifying sites for programmed maintenance works. When inspections are undertaken using a data capture device the date of the inspection will be recorded automatically. The inspection records will show the name of inspector who carried out the inspection, its date and if it was a walked or driven inspection.

Category 1 defects (24 Hour Repair) which require immediate attention should be transferred from the handheld device as soon as the inspection on a particular street has been completed. If it is not possible to transfer the Category 1 (24 Hour Repair) defect at the time of inspection, it must be transferred within 2 hours of it being recorded.

All Category 2 defects (30, 90 and 180 Day Repairs) should be transferred on the day of inspection. All inspections shall be properly recorded into CONFIRM and retained by the Council for future reference.

### **7.1 Recording of Defects**

In order to ensure that the maintenance teams identify and repair defects quickly and efficiently, it is important that the information provided by the Inspector is accurate and easily understood. To locate a defect efficiently, the maintenance teams require three pieces of information:

- A location on the street
- The position of the defect on the highway in relation to other key features
- Type of defect

The following combination should be used in order:

Information	Example
House number	Outside/Adjacent/Gable End of 21
Street lamp number	Opposite LC 001
Building name	Outside Civic Centre
Road junction	Junction with Chapel Ash

**Table 9 – Table Showing Examples of Defect Locations**

Building names can sometimes be difficult to locate especially on long roads, so if it is necessary to give a building name it would be helpful to the maintenance team to have some other additional information such as ‘Heantun House between LC001 and LC005’.

## 7.2 The Position of the Defect

The position of the defect on the highway is essential to help the Area Maintenance teams locate the defect that the Inspector wants them to repair, consistent terminology should be used which can be abbreviated. The following are examples of what can be used:

Channel of carriageway	CW CHNL	Back of footway	BOF
Adjacent to	ADJ	Gable end of	GE
Back of kerb	BOK	Outside	O/S
On verge	VG	Opposite	OPP
On pedestrian crossing	PDX	Vehicle Crossing	XING

**Table10 – Table Showing Examples of Defect Positions**

This list is by no means definitive. However, by using combinations of these and other similar terms it is possible to give simple but clear instructions on the data capture device which will help to accurately record the location of the defect.

Examples

- Outside Number 3 potholes in channel of carriageway
- Property name Heantun House, between LC001 and LC002. Sunken flag edge of kerb

### 7.3 Describing Defects

When describing a defect it will be necessary to refer to the particular materials which are affected by the defect. In some cases the defect may affect several materials and these will also need to be covered within the description.

i.e. outside 12 – Depression in bitmac footway 0.6 sq. m, 2 no sunken pcc kerbs, also 4 sq. m, of rocking pcc flags and 1 no 150 x 150 sunken traffic signals box. Such information is particularly helpful to the teams and reduces unproductive time. Where it is necessary to replace an item, if possible the product type and/or size should be given. For example:

5 x 10 (125 x 255) bull nose kerb
Road gully cover 255 x 300
Pcc footway dish channel 150 wide
Pcc flag 600 x 600

Table 11 – Table Showing Examples of Sizing Defects

Where there are items of defective street furniture it is important that the particular type of furniture is noted, if they have an asset tag/label the details need to be recorded as part of the defect record. Blue circular one way sign	SG1001
City centre bench	
Pedestrian Guard Railing	
City centre bollard with reflective banding	

Table 12 – Table Showing Examples of Street Furniture Defects

## **7.4 Sizing of Defects**

In many instances the team will be unable for practical reasons to repair the precise area of defective highway. It may be necessary for instance, to cut back on a defective area of bituminous surface beyond the defect itself to remove loose surfacing which is not visible to the eye. The complicated equipment necessary to undertake a repair may also require a minimum opening space to carry out its role effectively. As a general rule for the repair to potholes; areas should be recorded at a minimum of 300 x 300 and an allowance for cut back of 100mm on all sides should be made.

For repairs to flagged and bituminous surfacing it is acceptable that the measures given by the inspector on site are estimated and not precise, as these are not used for calculating costs. They are important however as they give the Area Maintenance teams a good indication of the materials they require and effort should be made to give relatively accurate estimates.

When appropriate and when safe to do so, the safety inspector will mark the total area of repair with either red spray paint or yellow chalk. Not only will this aid the Area Maintenance Teams in identifying the area, it will also highlight the immediate danger to the members of the public between the periods of identification and repair. All safety precautions should be assessed beforehand by the Inspector during the marking up process.

## **7.5 Taking Photos of Defects**

Where possible and safe to do so, the inspector will photograph all defects recorded as part of the inspection using the data capture device. Together with the defect details the photos will help Area Maintenance Teams to identify the defect, the materials required to undertake a repair and will also assist the Council in defending claims.

Photos should be taken once the defective area has been marked and should include the surrounding environment. This could include taking the photo at an angle to include a house number or shop name. All safety precautions should be assessed beforehand by the inspector during this process.

## **Appendix A: DEFECT RISK ASSESSMENT**

The current policy has been developed around our existing practices, the intention will be to adopt the approach to the assessment of risk detailed in the CoP, and the following will be used as the starting point for the development of a local standard.

*The principles of a system of defect risk assessment for application to safety inspections based on the guidance included in the current version of the CoP are set out below.*

*Any item with a defect level which corresponds to, or is in excess of, the stated defect investigatory level, is to be assessed for likely risk. The recommended procedure for risk assessment is as follows.*

### **Risk Identification**

*An inspection item for which the defect investigatory level is reached or exceeded is to be identified as a risk. The suggested inventory to be observed and examples of investigatory levels are detailed in Appendix B.*

### **Risk Evaluation**

*All risks identified through this process have to be evaluated in terms of their significance, which means assessing the likely impact should the risk occur and the probability of it actually happening.*

*A defect risk register will considerably assist the risk evaluation process.*

*Although it may not be possible to include every conceivable risk, the register identifies a wide range of risks likely to be encountered. This enables the vast majority of all risks actually encountered through comparison, interpolation or extrapolation, to be assessed with the identified risks. The risks contained in the register are based upon the highest assumed risk attributable to the type of defect, position and assessed type of usage. Local knowledge could assess the risk differently.*

### **Risk Impact**

*The impact of a risk occurring should be quantified on a scale of 1 to 4 assessed as follows:*

- *little or negligible impact;*
- *minor or low impact;*
- *noticeable impact;*
- *major, high or serious impact.*

*The impact is quantified by assessing the extent of damage likely to be caused should the risk become an incident. As the impact is likely to increase with increasing speed, the amount of traffic and type of road are clearly important considerations in the assessment.*

### **Risk Probability**

The probability of a risk occurring should also be quantified on a scale of 1 to 4 assessed as follows:

- very low probability;
- low probability;
- medium probability;
- high probability.

The probability is quantified by assessing the likelihood of users, passing by or over the defect, encountering the risk. As the probability is likely to increase with increasing vehicular or pedestrian flow, the network hierarchy and defect location are, consequently, important considerations in the assessment.

**Risk Factor**

The risk factor for a particular risk is the product of the risk impact and risk probability and is therefore in the range of 1 to 16. It is this factor that identifies the overall seriousness of the risk and consequently the appropriateness of the speed of response to remedy the defect. Accordingly, the priority response time for dealing with a defect can be determined by correlation with the risk factor, as shown in the Risk Matrix in Table 5 below.

**Risk Management**

Having identified a particular risk, assessed its likely impact and probability and calculated the risk factor, the category and the timescale to rectify the defect should be either defined as Category 1 response or allocated to one of the locally determined timescales for rectifying Category 2 defects as described in Section 9.4. The response category is represented by the coloured cells in Table 5 below.

**Table 5 – Risk Matrix**

Probability →	Very low (1)	Low (2)	Medium (3)	High (4)
Impact ↓				
Negligible (1)	1	2	3	4
Low (2)	2	4	6	8
Noticeable (3)	3	6	9	12
High (4)	4	8	12	16
Response Category	Category 2(L) response	Category 2(M) response	Category 2(H) response	Category 1 Response

## Appendix B: Intervention Levels

### Category 1 Intervention Levels

Our intervention level for Footway repairs is greater than 25mm.

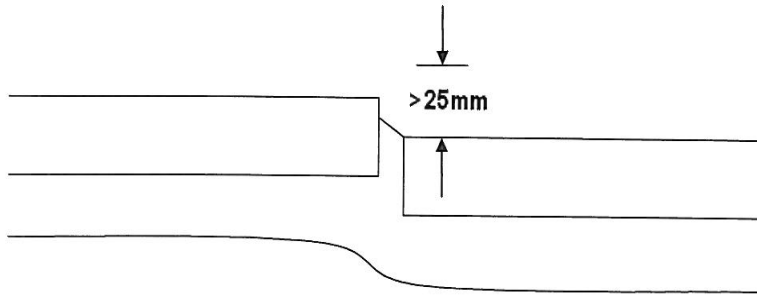

a) Footway – Modular - Trips greater than 25mm

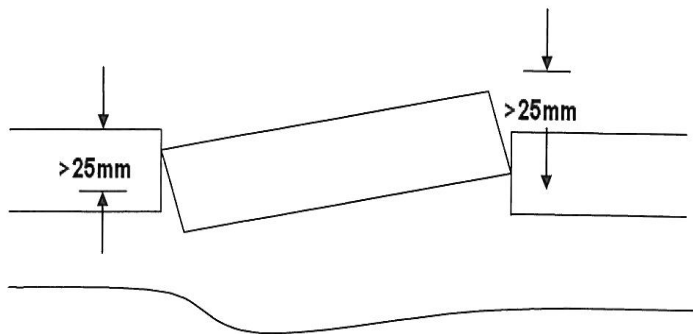

b) Footway – Modular - Rocking flags greater than 25mm

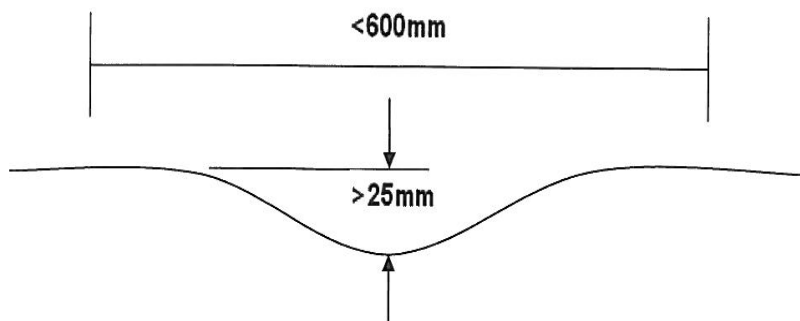

c) Footway – Bituminous - Change of footway profile greater than 25mm and extending in plan direct less than 600mm



Our intervention level for Carriageway repairs is greater than 50mm.

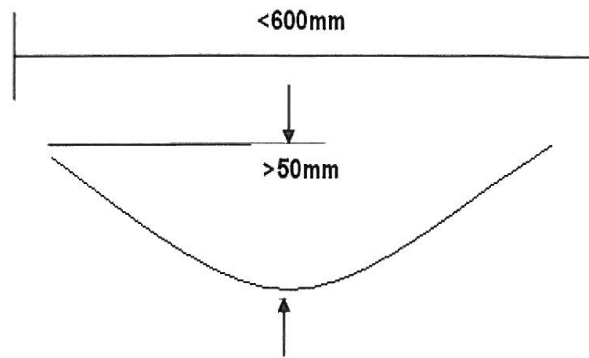

d) Carriageway – Bituminous - Change of carriageway profile greater than 50mm and extending in plan direct less than 600mm

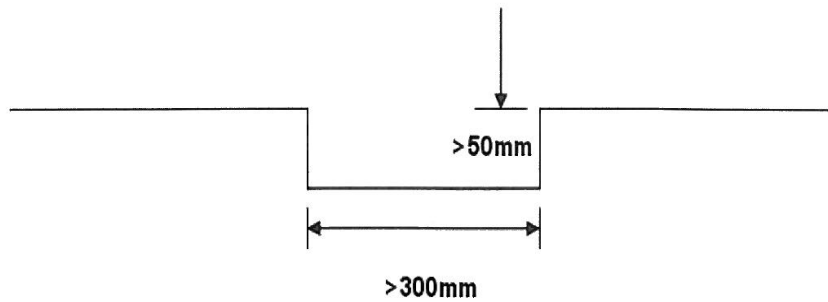

e) Carriageway - A depression (pot hole) of 50mm or greater in depth and extending in any one direction greater than 300mm may constitute a safety hazard

## Standard intervention levels for the identification of common highway defects

The list of possible defects that could be identified as part of a Safety Inspection, together with the suggested defect investigatory levels, are shown in the following table below. These intervention levels are indicative values only, the actual point at which intervention occurs will be determined by the onsite assessment risk process set out below with reference to the risk register:

Item	Defect	Suggested Cat 2 Investigatory Level
<i>Carriageway and Cycle Track</i>	<i>pothole / spalling</i>	<i>&gt;=20 mm depth (75mm across in any horizontal direction)</i>
	ridge	>=20mm
	hump	>=20mm
	depression / sunken cover	>=20mm
	gap / crack	>=20mm depth (□ 20mm width)
Footway (Prestige area)	trip / pothole / sunken cover	>=15 mm depth (75mm across in any horizontal direction)
	rocking slab / block	>=15mm vertical movement
	open joint	>=15mm depth (100mm □ 50mm horizontally)
Footway (others)	trip / pothole / sunken cover	>=20mm depth (75mm across in any horizontal direction)
	rocking slab / block	>=20mm vertical movement
	open joint	>=20mm depth (100mm □ 50mm horizontally)

Item	Defect	Suggested Investigatory Level
Kerb	misaligned	$\geq 50$ mm horizontally
	loose / rocking	$\geq 20$ mm vertically
	missing	yes / no
Verge	sunken area adjacent to and running parallel with c/way or f/way edge obstruction	depth $\geq 50$ mm  yes / no
iron works	gaps within framework (other than designed by manufacturer)	$\geq 20$ mm
	level differences within framework or with the adjacent surface.	$\geq \pm 10$ mm
	rocking covers	$\geq 15$ mm vertical movement
	cracked / broken covers	yes / no
	worn / polished covers	yes / no
	missing covers	yes / no
flooding	standing water 2 hours after cessation of rainfall (non Event Storm)	yes / no
	substantial running water across carriageway	yes / no
	substantial running water across footway	yes / no
	property inundation due to failure of highway drainage	yes / no

Item	Defect	Suggested Investigatory Level
drainage	blocked gully (silted above outlet)	yes / no
	collapsed / blocked / settled items or systems	yes / no
road markings	faded or worn markings	>=30% loss of effective markings (Stop lines >=25%)
road studs	missing	yes / no
	hole left in c/way	>=20mm depth (75mm across in any horizontal direction)
	displaced loose item on c/way	yes / no
	defective item	yes / no
Signs/Bollards/ Lights/ Traffic Signals	Street damaged/misaligned/loose item causing a hazard	yes / no
	missing item causing a hazard	yes / no
	lights/signals not operating correctly/malfunctioning	yes / no
	signals pointing the wrong way	yes / no
	signal lamp failure	yes / no
	exposed wiring	yes / no
	missing door to lamp column	yes / no
	item missing	yes / no
	item obscured/dirty/faded	yes / no
Severe corrosion to post or column so as to jeopardize structural integrity	yes / no	

<b>Item</b>	<b>Defect</b>	<b>Suggested Investigatory Level</b>
safety fencing and barriers	item damaged or misaligned causing a hazard	yes / no
	unstable item or section	yes / no
Structures, Bridges Tunnels	Damaged parapets	yes / no
	Damage likely to cause a hazard	yes / no
hedges trees grass	unstable tree causing danger of collapse onto highway	yes / no
	visibility impeded or obscuring signs and signals	yes / no
	Overhanging tree or hedges causing reduction in width	yes / no
	overhanging tree leading to loss of height clearance over carriageway, footway or Cycle Track	yes / no < 2.1m over Footways < 2.4m over Cycle Track < 5.1m over Carriageways

Item	Defect	Suggested Investigatory Level
highway general	oil / debris / mud / stones and gravel likely to cause a hazard	yes / no
	street furniture missing / damaged likely to cause a hazard	yes / no
	illegal signs	yes / no
	obstructions in the highway	yes / no
	obstructed sight lines	yes / no
	ramps in carriageway to aid vehicular movement	yes / no
	f/way damage caused by vehicular access where no vehicle crossing	yes / no
	scaffolding likely to cause a hazard	yes / no
	skips likely to cause a hazard	yes / no
	unprotected building materials on the highway	yes / no
	abandoned vehicles likely to cause a hazard	yes / no
	offensive graffiti	yes / no
	slippage in embankments and cuttings	yes / no
other dangers to the public	anything else considered dangerous	yes / no

### Appendix C: Inspection Process in Confirm

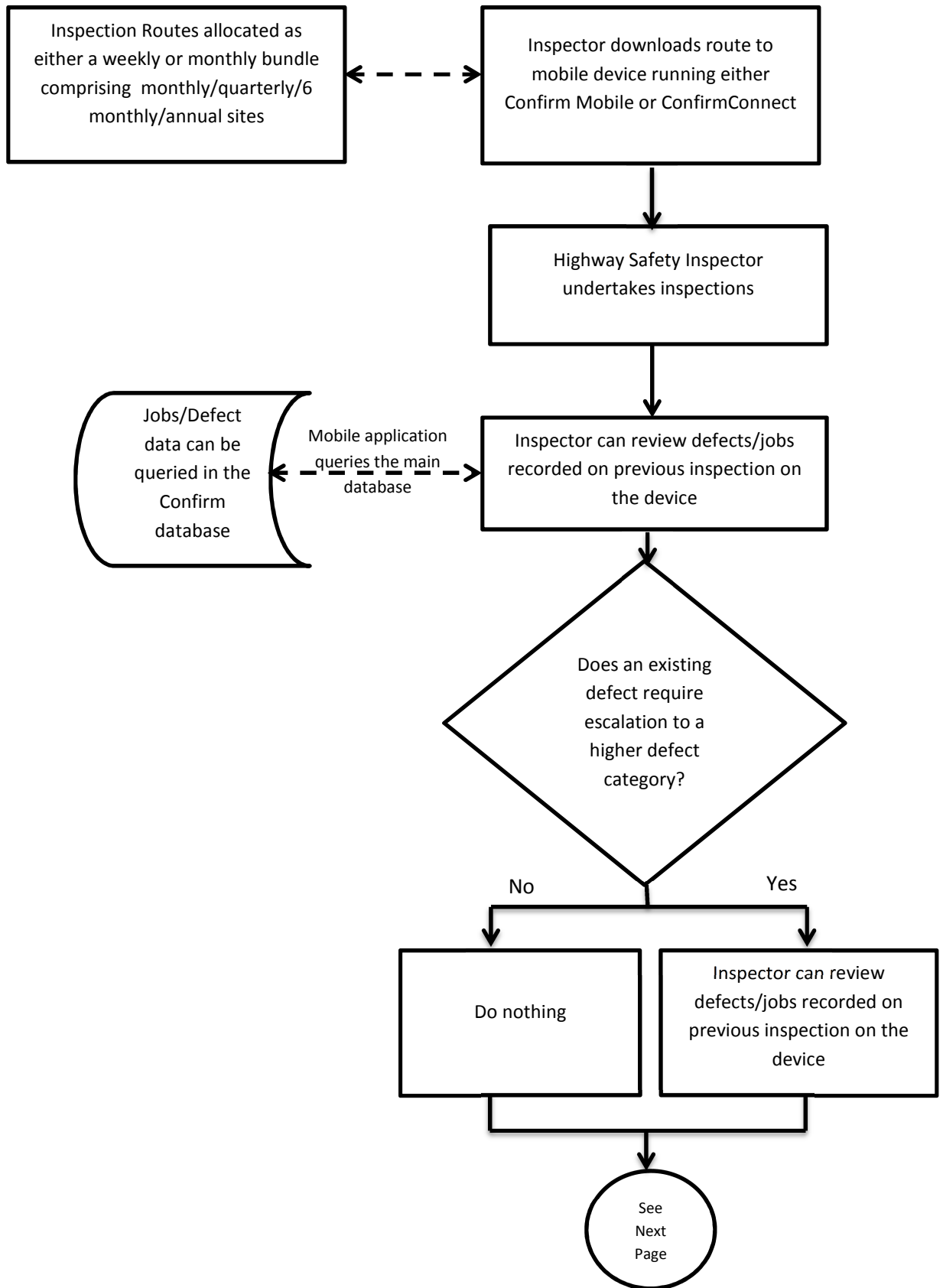

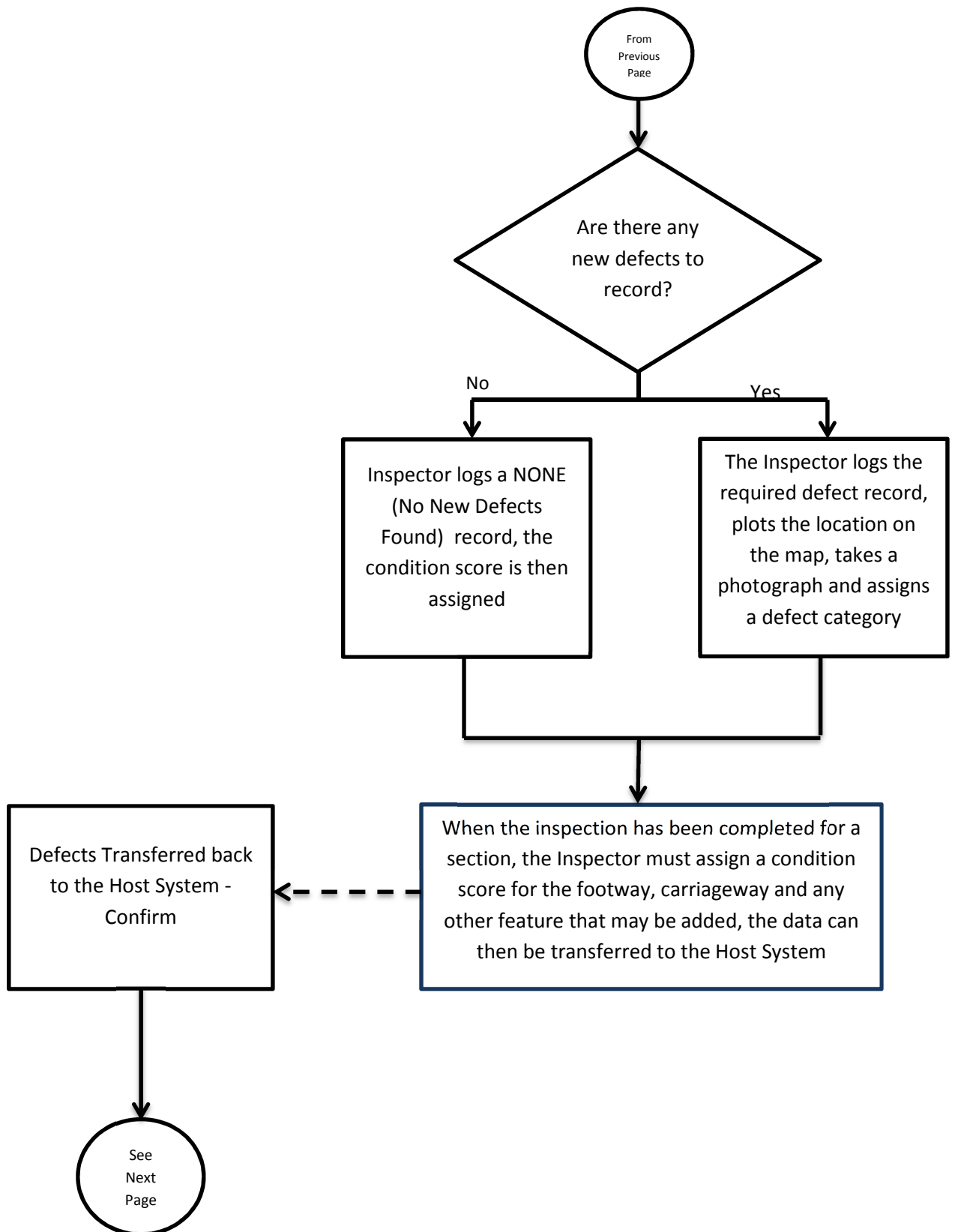



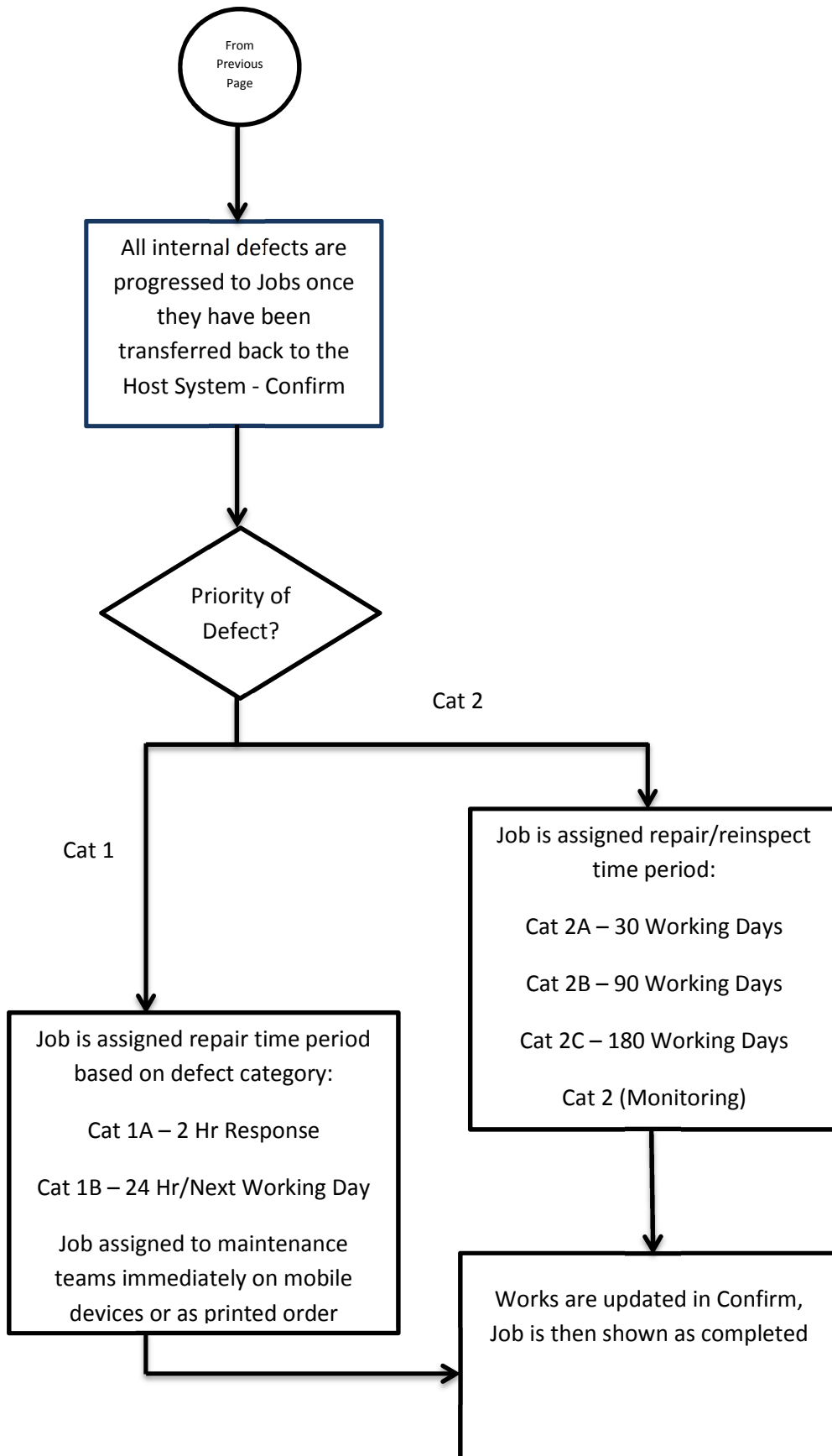



Appendix D: Risk Assessment  
Risk Assessment & Safe Systems of work

Highway Inspections

It is important to know that any activity on the highway be it a motorway or a 20mph home zone street can be potentially hazardous & has an inherent risk attached to it.

The Council undertakes cyclic highway safety inspections on all its adopted highways in order to comply with its duty to maintain its highways as outlined within Section 41 of the Highways Act 1980 and to support the special defence as defined in Section 58 of the Act.

This safe system of work has therefore been developed with the primary aim of providing assistance to those officers involved in undertaking highway safety inspections so that they may carry out their duties with safety and to clear recognised and understood criteria.

An assessment of health and safety hazards associated with any particular task process of work or other operation. (Health and Safety at Work Regulations 1992). The purpose behind the Risk Assessment is to evaluate the level of hazard and to introduce appropriate control measures to reduce the risks from such hazards to acceptable levels.

Everyone required to work on the highway should be aware that they have a responsibility for the safety of themselves and others. The term '**Site**' means all locations on the Public Highway, Council Land, Private Land and all types of Construction Sites.

<p><u>Hours of Work</u></p>	<p>When carrying out highway inspections it is important that consideration must be given to day light hours &amp; the hours of work will need to be adjusted during winter months when light is an issue. Any work that needs to be undertaken during the hours of darkness will need to be approved with your line manager prior to commencing.</p>
<p><u>Leaving the Office</u></p>	<p>Before leaving the office you must do one of the following:</p> <ul style="list-style-type: none"> <li>• Leave details in writing by signing out using the signing out book and sign the whereabouts board situated to the rear of the office.</li> <li>• Leave details verbally with your line manager</li> </ul> <p>Please indicate in the book, on the board or with your line manager the following:</p> <ul style="list-style-type: none"> <li>• Your expected movements</li> <li>• Where you are going initially,</li> <li>• Where you intend to go</li> <li>• The time &amp; date you left and are expected back in to the office.</li> <li>• If you intend to finish or start work on site please state this &amp; verbally agree this with your line manager.</li> </ul>

	<ul style="list-style-type: none"> <li>If you have been issued with a mobile telephone then you must ensure that this is taken with you and is switched on and used in accordance with the law.</li> </ul>
<b><u>On Site</u></b>	Once on site park your vehicle in a safe place or park in an allocated car park on site if available. It is your responsibility to park legally and safely, parking fines will not be paid by the council. Keep all valuables out of display.
<b><u>Personal Protective Equipment</u></b>	<p><b><u>When working on site you must wear at all times:</u></b></p> <ul style="list-style-type: none"> <li>High visibility reflective jacket conforming to BS EN 471 Class 3</li> <li>Safety boots conforming to BS EN246 with ankle supports.</li> <li>You must also wear or use any other equipment in the correct manner that has been provided by the council such as safety helmets, gloves etc. and you must not intentionally damage or deface any equipment that has been provided by the council to protect you.</li> <li>If you require any personal protective equipment then please consult your line manager or health safety officer. These will be provided by the city council free of charge.</li> </ul>
<b><u>Highway Inspections In vehicles</u></b>	<ul style="list-style-type: none"> <li>Driven surveys will be undertaken in a city council slow-moving, high visibility with orange strobes vehicle.</li> <li>The driven survey must not under no circumstances be carried out in personal vehicles.</li> <li>The driven inspection must be carried out with both a driver &amp; inspecting officer under no circumstances must a driven inspection be carried out by one officer.</li> <li>Both the driver &amp; inspecting officer must wear a high visibility reflective jacket conforming to BS EN 471 &amp; safety boots conforming to BS EN246 with ankle supports both inside &amp; outside of the vehicle.</li> <li>The vehicle must be checked for any faults using a defect book provided.</li> <li>If a fault is found and the vehicle is not road worthy then it must be reported immediately to your line manager and must not be used until it is repaired. A sign will also need to be displayed on the windscreen stating that the vehicle is off road (V.O.R).</li> <li>When the vehicle is undertaking a driven survey the orange flashing strobe lights will needed to be switched on and the vehicle will need to display all the necessary livery and warning signs to inform other road users that a highway inspection is in process.</li> <li>The driven survey must be carried out during off peak hours between 09:30 -1530 hrs to minimize any disruption to other road users.</li> <li>Vehicle-based inspections will involve a driver accompanied by the inspecting officer, but in cases</li> </ul>

	<p>where it is difficult to obtain the necessary level of accuracy through this method, inspectors will walk the route instead, provided a footpath is used to carry out this inspection.</p> <ul style="list-style-type: none"> <li>• The vehicle must comply with all road traffic laws and be used in a courteous manner; the council will not pay any fines or parking tickets this will be the responsibility of the driver.</li> <li>• If a defect is noted it on the highway it may be necessary for you to park the vehicle so as to provide protection from oncoming traffic this must only be done in a council vehicle and you must operate the orange flashing light and display all warnings signs, this must also be done safely by being visible to traffic and not to cause a hazard.</li> <li>• Driving must be shared between therefore officers must adhere to the European drivers' hours rules which require that after 4½ hours driving, a driver must take a break of at least 45 minutes.</li> </ul>
<p><b><u>WEATHER CONDITIONS</u></b></p>	<p><b><u>Inclement weather</u></b></p> <ul style="list-style-type: none"> <li>• Before commencement of inspections, weather forecasts should be consulted to confirm the likelihood of satisfactory visibility.</li> <li>• All surveys driven or walked must not be carried out in inclement weather conditions that reduce visibility.</li> <li>• During inclement weather conditions it may be necessary for you to cease the survey and return to the office or you may wish to park the vehicle safely &amp; allow the weather to clear.</li> </ul> <p><b><u>Hot Weather</u></b></p> <p>Ensure that you take regular breaks and carry a bottled cold drink with you on order to avoid dehydration.</p>
<p><b><u>ROAD TRAFFIC COLLISION</u></b></p>	<p>If you are the driver and one or more of the following has happened:</p> <ul style="list-style-type: none"> <li>• A person, other than yourself, is injured</li> <li>• Damage is caused to another vehicle or to someone else's property</li> <li>• An animal has been killed or injured</li> </ul> <p><b>You must:</b></p> <ul style="list-style-type: none"> <li>• First of all stop.</li> <li>• If there are any injuries dial 999 for emergency services.</li> <li>• Exchange insurance details, obtain registration numbers of vehicles, names &amp; addresses of person(s) involved &amp; any witnesses to the collision.</li> <li>• You must do these things not only when you are directly involved in an injury accident, but also if your vehicle's 'presence' was a factor.</li> <li>• You must under no circumstances leave the scene of an accident without doing any of these, this will not</li> </ul>

	<p>only be a disciplinary offence but is also a criminal offence.</p> <ul style="list-style-type: none"> <li>• You must not enter into any discussion on fault or blame, this would be a matter for the council to deal with at a later stage.</li> <li>• Once you are clear to leave the scene you must inform your line manager at your earliest opportunity and fill out a accident report form within 24hours.</li> </ul>
<p><b><u>Walked Inspections</u></b></p>	<ul style="list-style-type: none"> <li>• When carrying out a detailed walked inspection, pavements (including any path along the side of a road) should be used if provided, if there is no pavement then the route should be undertaken as a driven survey.</li> <li>• Always ensure you look where you are walking where possible, avoid being next to the kerb with your back to the traffic, always face on-coming traffic as far as practicable.</li> <li>• If you need to step into the road, try to use a appropriate crossing point and look both ways first, always show due care and consideration for others.</li> <li>• Avoid crossing between parked cars; try not to cross in places where traffic cannot see you, as you cross keep looking both ways.</li> <li>• Ensure that you wear safety footwear that conforms to BS EN246 with suitable ankle supports to protect feet and ankles in the event of any slips or trips &amp; a high visibility reflective jacket conforming to BS EN 47 Class three is worn.</li> </ul>

## Appendix E; Inspection Routes

### City Centre Inspection Routes

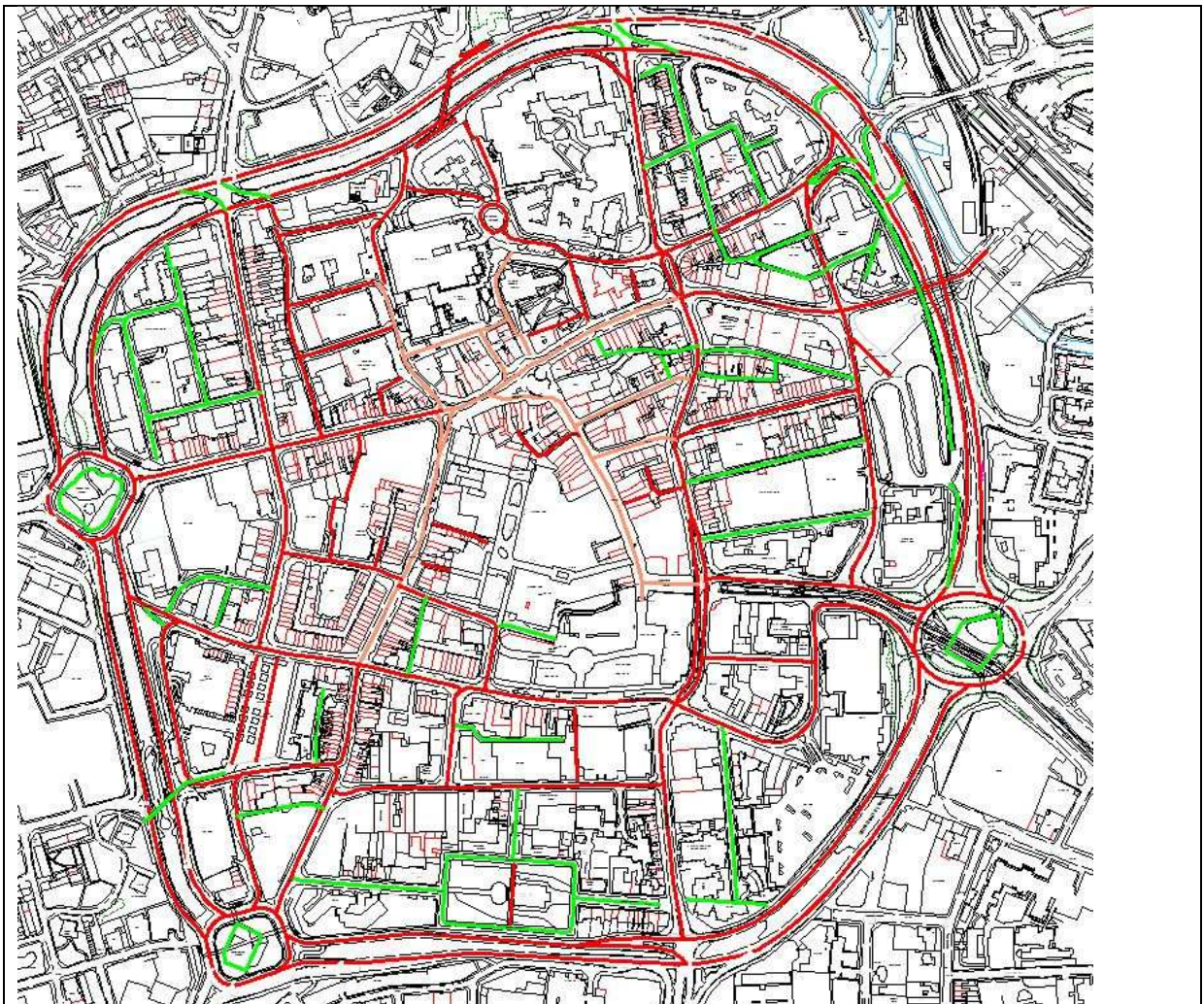

#### Wolverhampton City Centre Highway Safety Inspection Routes

The coloured centre-line indicates those sites included in the current inspection programme

Red & Orange – Monthly Inspection

Green – Quarterly Inspection

#### WCC\_Network by FwayH

- 1 (90)
- 1a (15)
- 2 (49)

## Bilston Town Centre

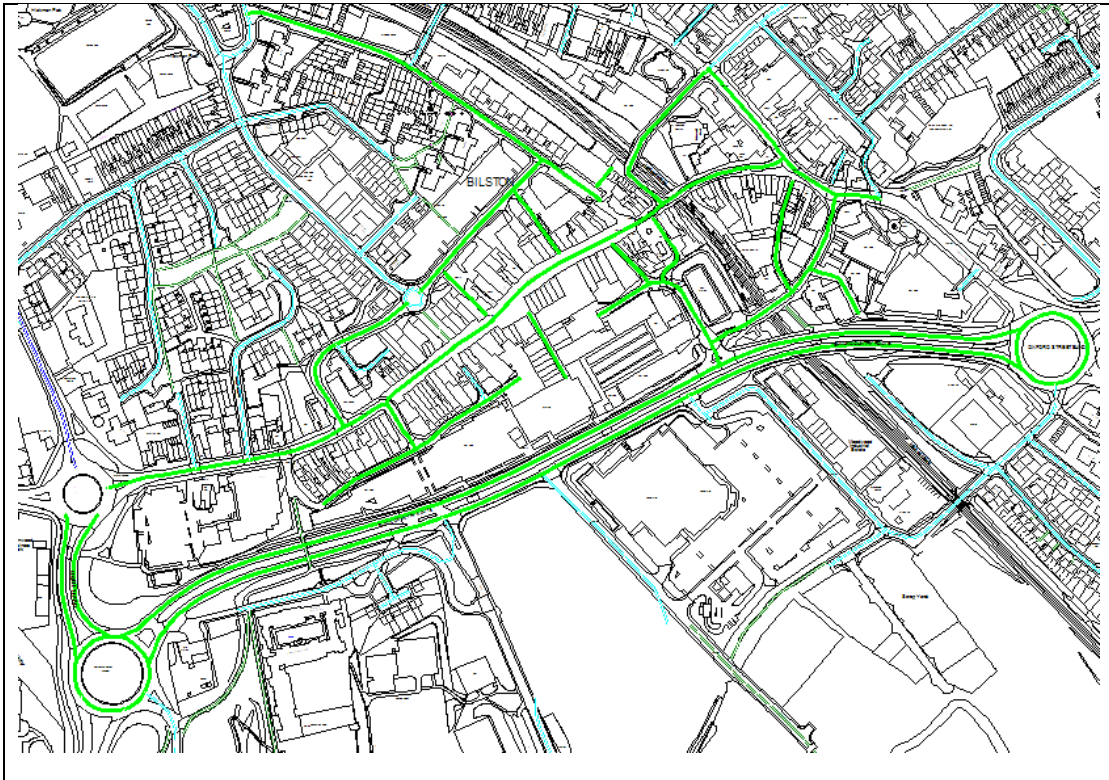

Bilston Town Centre – Highway Safety Inspection Route

The green centre-line indicates those sites included in the monthly inspection



## Wednesfield Town Centre



### Wednesfield Town Centre – Highway Safety Inspection Route

The green centre-line indicates those sites included in the monthly inspection

## Monthly Driven Inspection Routes

site_code	plot_no	site_name	feature_location	Length	unit
44805020	10001	BLACK COUNTRY ROUTE	BLACK COUNTRY ROUTE - EB BIRMINGHAM NEW ROAD - RBT OVERFIELD DRIVE	242.42	Metres
44805020	10002	BLACK COUNTRY ROUTE	BLACK COUNTRY ROUTE - WB RBT OVERFIELD DRIVE - BIRMINGHAM NEW ROAD	242.57	Metres
44805020	10003	BLACK COUNTRY ROUTE	BLACK COUNTRY ROUTE - RBT OVERFIELD DRIVE - FROM WEST ENTRANCE	122.24	Metres
44805020	10004	BLACK COUNTRY ROUTE	BLACK COUNTRY ROUTE - EB RBT OVERFIELD DRIVE - RBT SPRINGVALE WAY	792.59	Metres
44805020	10005	BLACK COUNTRY ROUTE	BLACK COUNTRY ROUTE - WB RBT SPRINGVALE WAY - RBT OVERFIELD DRIVE	797.98	Metres
44805020	10006	BLACK COUNTRY ROUTE	BLACK COUNTRY ROUTE - RBT SPRINGVALE WAY - FROM SOUTHWEST ENTRANCE	143.18	Metres
44805020	10007	BLACK COUNTRY ROUTE	BLACK COUNTRY ROUTE - NB RBT plkkNGVALE WAY - RBT COSELEY ROAD	419.86	Metres
44805020	10008	BLACK COUNTRY ROUTE	BLACK COUNTRY ROUTE - SB RBT COSELEY ROAD - RBT SPRINGVALE WAY	420.22	Metres
44805020	10009	BLACK COUNTRY ROUTE	BLACK COUNTRY ROUTE - RBT COSELEY ROAD - FROM SOUTH ENTRANCE	213.26	Metres
44805020	10010	BLACK COUNTRY ROUTE	BLACK COUNTRY ROUTE - EB RBT COSELEY ROAD - RBT OXFORD STREET	877.69	Metres
44805020	10011	BLACK COUNTRY ROUTE	BLACK COUNTRY ROUTE - WB RBT OXFORD STREET - RBT COSELEY ROAD	870.79	Metres
44805020	10012	BLACK COUNTRY ROUTE	BLACK COUNTRY ROUTE - RBT OXFORD STREET - FROM WEST ENTRANCE	201.04	Metres
44805020	10013	BLACK COUNTRY ROUTE	BLACK COUNTRY ROUTE - EB RBT OXFORD STREET - RBT HARE STREET	321.53	Metres
44805020	10014	BLACK COUNTRY ROUTE	BLACK COUNTRY ROUTE - WB RBT HARE STREET - RBT OXFORD STREET	322.06	Metres

44805020	10015	BLACK COUNTRY ROUTE	BLACK COUNTRY ROUTE - RBT HARE STREET - FROM NORTHWEST ENTRANCE	201.17	Metres
44805020	10016	BLACK COUNTRY ROUTE	BLACK COUNTRY ROUTE - EB RBT HARE STREET - RBT BLACK COUNTRY NEW ROAD	768.3	Metres
44805020	10017	BLACK COUNTRY ROUTE	BLACK COUNTRY ROUTE - WB RBT BLACK COUNTRY NEW ROAD - RBT HARE STREET	764.05	Metres
44805020	10018	BLACK COUNTRY ROUTE	BLACK COUNTRY ROUTE - RBT BLACK COUNTRY NEW ROAD - FROM WEST ENTRANCE	334.35	Metres
44805020	10019	BLACK COUNTRY ROUTE	BLACK COUNTRY ROUTE - EB RBT BLACK COUNTRY NEW ROAD - DARLASTON LANE	403.45	Metres
44805020	10020	BLACK COUNTRY ROUTE	BLACK COUNTRY ROUTE - WB DARLASTON LANE - RBT BLACK COUNTRY NEW ROAD	428.63	Metres
44805020	10021	BLACK COUNTRY ROUTE	BLACK COUNTRY ROUTE - SB SLIP ON - BIRMINGHAM NEW ROAD	53.63	Metres
44805020	10022	BLACK COUNTRY ROUTE	BLACK COUNTRY ROUTE - FOOTWAY AND CYCLE TRACK FROM LUNT ROAD TO DARLASTON LANE	852	Metres
44805040	10001	BLACK COUNTRY NEW ROAD	BLACK COUNTRY NEW ROAD - SB RBT BLACK COUNTRY ROUTE - CITY BOUNDARY	354.05	Metres
44805040	10002	BLACK COUNTRY NEW ROAD	BLACK COUNTRY NEW ROAD - NB CITY BOUNDARY - RBT BLACK COUNTRY ROUTE	355.31	Metres
44842480	10003	RING ROAD	RING ROAD - RBT PENN ROAD ISLAND - FROM EAST ENTRANCE	264.79	Metres
44842480	10006	RING ROAD	RING ROAD - RBT CHAPEL ASH - FROM SOUTH ENTRANCE	276.29	Metres
44842480	10014	RING ROAD	RING ROAD ST DAVIDS - SB BROAD STREET - RBT BILSTON ROAD	513.36	Metres
44842480	10015	RING ROAD	RING ROAD ST DAVIDS - NB RBT BILSTON ROAD - BROAD STREET	462.94	Metres
44842480	10016	RING ROAD	RING ROAD - RBT BILSTON ROAD - FROM NORTH ENTRANCE	333.45	Metres

## Appendix F: Network Categorisation Record

This sheet is to be used to record changes to a sites hierarchy categorisation and safety inspection frequency:

### Network Categorisation Record







Site Name								District			
								Ward			
Section Label								Section No			
From								To			
Current Inspection Frequency						Proposed Inspection Frequency					
Site Features											
Dft Road Class		3 / 4 / 5 / 6 / NC									
LHS				Carriageway				RHS			
Verge		Footway						Footway		Verge	
Outer	Inner	Outer	Inner					Outer	Inner	Outer	Inner
		Amendment/Changes Required						Yes / No			
		Current				Revised/ Amended					
		Code		Description		CoP Frequency		Code		Description	
Carriageway Hierarchy											
Footway Hierarchy											
Cycle Route Hierarchy											
Nature Of Site		Residential		Mixed		Commercial		Industrial		Retail	
Current Usage											
Proposed Usage											
Bus Route		Yes/No				Frequency		High/Medium/Low			
Traffic Flow*		High/Med/Low									
Pedestrian Volume*		High/Med/Low									
Sites Claim /Accident History											
Character and Traffic Use Of Adjoining Highway*											
Reviewed By								Date			
Approved By								Date			
<p>*This is based on what the section connects to/from, use the text description associated with the hierarchy definition; Particular local circumstances, such as proximity to school, hospitals, medical centres should be taken into account in determining inspection frequency</p>											
Page 1 of 2											







Notes: Footway and carriageway hierarchy, will not necessarily be determined by the road classification, but the functionality of the footway or carriageway and scale of use. In urban areas the contribution of the footway to the quality of public space and streetscene will be particularly important.







Local factors such as the age, distribution of the population, the proximity of schools, shops, health centres or other establishments attracting higher than normal numbers of pedestrians/traffic to the site.

Feature		Category	Inspection Frequency
<b>Carriageways</b>			
2	Strategic Routes	Principal 'A' Roads	1 month
3(a)	Main Distributors	Classified Non-Principal B Roads	1 month
3(b)	Secondary Distributors	Classified Non-Principal C Roads and other locally significant routes	1 month
4(a)	Link Access	Roads linking between the Main and Secondary Distributor Network with frontage access and frequent junctions.	3 Months
4(b)	Local Access	Roads serving limited numbers of properties carrying only access traffic.	1 Year
<b>Footways</b>			
1(a)	Prestige Area	Very busy areas of towns and cities with high public space and street scene contribution.	1 Month
1	Primary Walking Route	Busy urban shopping and business areas and main pedestrian routes.	1 Month
2	Secondary Walking Route	Medium usage routes through local areas feeding into primary routes, local shopping centres, etc.	3 Months
3	Link Footway	Other footways alongside roads with carriageway categories 2, 3a, 3b and 4a	6 Months
4	Local Access Footway	Footways alongside local access roads (carriageway category 4b) and footpaths within estates.	1 Year





**Appendix G: Confirm – Highway Defect Codes**









Defect Type Code	Defect – Short Description		
CAT1	NO NEW CAT 1 DEFECTS NOTED		
CWDA	Cway Damaged		
			
CWDE	Cway Depression		

CWDS	Cway Det Surrounding		
			
CWHF	Cway High Friction Surf Damage		
CWLW	Cway Excess Litter/Weeds		
CWOV	Cway Overhanging Vegetation		

CWPH	Cway Pothole		
			
CWPO	Cway Ponding		
CWRE	Cway Reinstatement Failure		

















<p><b>CWUN</b></p>	<p><b>Cway Uneven</b></p>		
			
<p><b>FTBL</b></p>	<p><b>Fway Trough Blockage</b></p>		











<p><b>FTDA</b></p>	<p><b>Fway Trough Damaged</b></p>		
<p><b>FTDI</b></p>	<p><b>Fway Trough Displaced</b></p>		
<p><b>FTLO</b></p>	<p><b>Fway Trough Loose</b></p>		
<p><b>FTMI</b></p>	<p><b>Fway Trough Missing</b></p>		









			
<b>FWDA</b>	<b>Footway Damaged</b>		
			
<b>FWDE</b>	<b>Footway Depression</b>		

			
<b>FWDS</b>	<b>Footway Det Surrounding</b>		
<b>FWLO</b>	<b>Footway Loose</b>		
			
<b>FWLW</b>	<b>Footway Excess Litter/Weeds</b>		

FWMI	Footway Missing		
			
FWOV	Fway Overhanging Vegetation		
FWPH	Footway Pothole		







			
<b>FWPO</b>	<b>Footway Ponding</b>		
<b>FWRE</b>	<b>Fway Reinstatement Failure</b>		
<b>FWUN</b>	<b>Footway Uneven</b>		
<b>GBDE</b>	<b>Grit Bin Defect</b>		
<b>GYBL</b>	<b>Gully Blockage</b>		







GYDA	Gully Damaged		
			
GYDI	Gully Displaced		
			
GYLO	Gully Loose		

GYMI	Gully Missing		
KBDA	Kerb Damaged		
			
KBDI	Kerb Displaced		









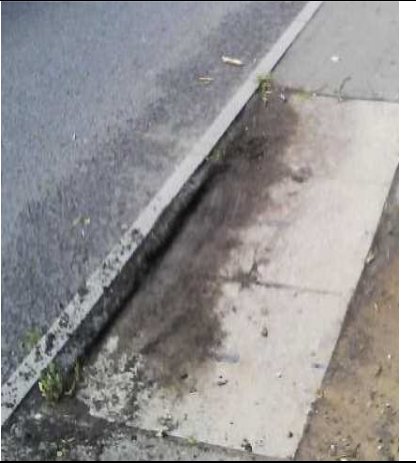

KBLO	Kerb Loose		
KBMI	Kerb Missing		
KBUN	Kerb Uneven		
LTDE	Litter Bin Defect		









MHDA	Manhole Damaged		
MHDI	Manhole Displaced		
MHLE	Manhole Water Leakage		
MHLO	Manhole Loose		
MHMI	Manhole Missing		
NONE	No New Defect Found		
OTHE	Other		

PRDA	Ped Guardrail Damaged		
			
			
PRDI	Ped Guardrail Displaced		
PRLO	Ped Guardrail Loose		

PRMI	Ped Guardrail Missing		
PUDA	Public Utility Damaged		
			
			







PUDI	Public Utility Displaced		
PULE	Public Utility Water Leakage		
PULO	Public Utility Loose		
			





<p><b>PUMI</b></p>	<p><b>Public Utility Missing</b></p>		
			
<p><b>RMDA</b></p>	<p><b>ROAD MARKING DAMAGE</b></p>		
			







SBDA	Bollard Damaged		
			
SBDI	Bollard Displaced		
SBLO	Bollard Loose		







SBMI	Bollard Missing			
SFDE	Street Furniture Defect			
				
SGDA	Unlit Sign Damaged			
				



SGDI	Unlit Sign Displaced		
SGLO	Unlit Sign Loose		
SGMI	Unlit Sign Missing		
SGNP	Unlit Sign Naked Pole		

SLDA	Street Lighting Damaged		
SLDI	Street Lighting Displaced		
SLLO	Street Lighting Loose		
SLLW	SL All Lights Out		

SLMI	Street Lighting Missing		
SLYW	SL All Lights Dayburning		
SNDA	Street Nameplate Damaged		
SNDI	Street Nameplate Displaced		
SNMI	Street Nameplate Missing		

TSDA	Traffic Signal Damaged		
TSDI	Traffic Signal Displaced		
TSLO	Traffic Signal Loose		
TSMI	Traffic Signal Missing		
VGDA	Verge Damaged		
VGDE	Verge Depression		
VGLW	Verge Excess Litter/Weeds		

VGPH	Verge Pothole			
VGPO	Verge Ponding			
VGRE	Verge Reinstatement Failure			